

B208B Technical Data Sheet

Chrome Plated Brass Ball and Nickel Plated Brass Stem

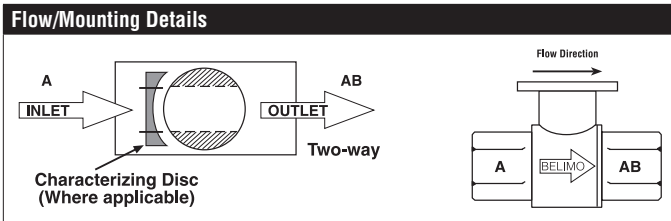

Technical Data	
Fluid	chilled or hot water, up to 60% glycol
Flow characteristic	equal percentage
Controllable flow range	75°
Valve Size [mm]	0.5" [15]
Pipe connection	NPT female ends
Housing	Nickel-plated brass body
Ball	chrome plated brass
Stem	nickel-plated brass
Stem seal	EPDM (lubricated)
Seat	PTFE
O-ring	EPDM (lubricated)
Characterized disc	TEFZEL®
Body Pressure Rating	600 psi
Close-off pressure Δps	200 psi
Cv	0.46
Weight	0.44 lb [0.20 kg]
Fluid Temp Range (water)	0...250°F [-18...120°C]
Leakage rate	0% for A – AB
Servicing	maintenance-free



Application

This valve is typically used in air handling units on heating or cooling coils, and fan coil unit heating or cooling coils. Some other common applications include Unit Ventilators, VAV box re-heat coils and bypass loops. This valve is suitable for use in a hydronic system with variable flow.

Suitable Actuators

	Non-Spring	Spring
B208B	TR, LRB(X)	TFRB(X), LF

Dimensions (Inches [mm])



A	B	C	D	E	F	H1	H2
9.4" [239]	2.4" [60]	5.2" [132]	4.6" [117]	1.3" [33]		1.2" [30]	1.1" [28]

Safety Notes

WARNING: This product can expose you to lead which is known to the State of California to cause cancer and reproductive harm. For more information go to www.p65warnings.ca.gov

Dimensions (Inches [mm])

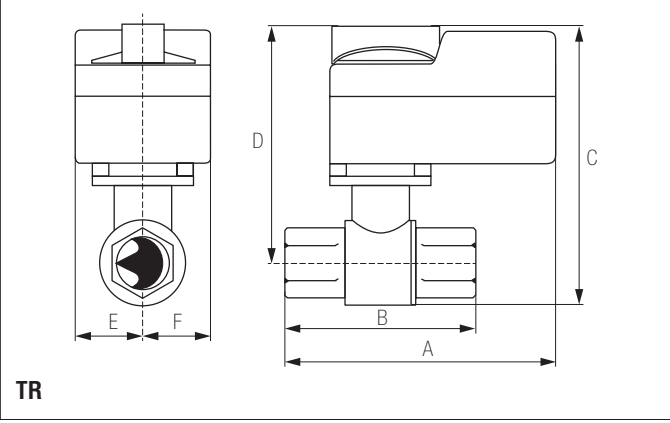

A	B	C	D	E	F
3.7" [95]	2.4" [60]	4.8" [122]	4.2" [107]	1.3" [33]	

Dimensions (Inches [mm])

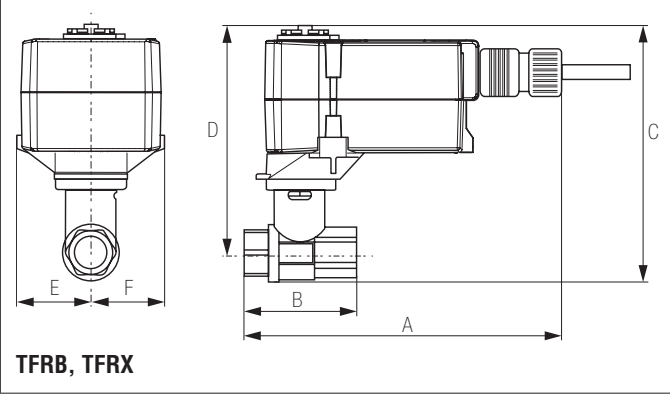

A	B	C	D	E	F
6.6" [167]	2.4" [60]	4.9" [124]	4.3" [110]	1.5" [39]	

Dimensions (Inches [mm])

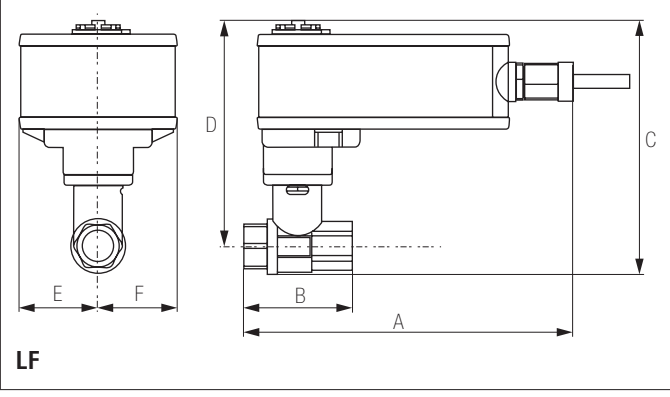

A	B	C	D	E	F
7.9" [200]	2.4" [60]	5.7" [146]	5.1" [129]	1.8" [46]	

Date created, 12/09/2019 - Subject to change. © Belimo Aircontrols (USA), Inc.

LF120 US, Valve Actuator Technical Data Sheet

On/Off, Spring Return Fail-Safe, AC 120 V



5-year warranty







Technical Data

Power Supply	120 VAC, $\pm 10\%$, 50/60 Hz
Power consumption in operation	5.5 W
Power consumption in rest position	3.5 W
Transformer sizing	7.5 VA
Electrical Connection	18 GA appliance cable, 3 ft [1 m], with 1/2" conduit connector
Overload Protection	electronic throughout 0...95° rotation
Angle of rotation	90°
Direction of motion motor	selectable with switch 0/1
Direction of motion fail-safe	reversible with cw/ccw mounting
Position indication	Mechanical
Running Time (Motor)	75 s
Running time fail-safe	<25 s @ -4...122°F [-20...50°C], <60 s @ -22°F [-30°C]
Ambient humidity	max. 95% r.H., non-condensing
Ambient temperature	-22...122°F [-30...50°C]
Storage temperature	-40...176°F [-40...80°C]
Degree of Protection	IP54, NEMA 2
Agency Listing	cULus acc. To UL 873 and CAN/CSA C22.2 No. 24-93
Noise level, motor	50 dB(A)
Noise level, fail-safe	62 dB(A)
Servicing	maintenance-free
Quality Standard	ISO 9001
Weight	3.4 lbs (1.54 kg.)

†Rated Impulse Voltage 800V, Type of action 1.AA, Control Pollution Degree 3

Wiring Diagrams

✂ INSTALLATION NOTES

-  Actuators with appliance cables are numbered.
-  Provide overload protection and disconnect as required.
-  Actuators may be connected in parallel if not mechanically linked. Power consumption and input impedance must be observed.
-  Meets cULus requirements without the need of an electrical ground connection.

 WARNING! LIVE ELECTRICAL COMPONENTS!
 During installation, testing, servicing and troubleshooting of this product, it may be necessary to work with live electrical components. Have a qualified licensed electrician or other individual who has been properly trained in handling live electrical components perform these tasks. Failure to follow all electrical safety precautions when exposed to live electrical components could result in death or serious injury.

